



**INOX** **B.l.m.**  
KITCHEN EQUIPMENT

**Mac***Chef*  
*Solutions for Catering*

**Cottura serie 700/900 passo 400/450**

Cooking series 700/900 mm 400/450  
Cuisson série 700/900 bloc de 400/450  
Kochfeld Serie 700/900 Breite 400/450

# Caratteristiche generali

## General features

## Caractéristiques générales

## Allgemeine Charakteristiken

 I piani di cottura, i cruscotti e le parti esterne a vista sono realizzate in acciaio inox AISI 304 mentre il resto è in AISI serie 400 comprese le parti interne come camere di combustione e camini interni (evidenziamo che per le parti interne di norma viene utilizzata la lamiera zincata).  
I condotti gas dei bruciatori primari vengono realizzati in tubo inox flessibile.  
L'accensione, ove prevista, avviene tramite generatore meccanico piezo.

 The hobs, boards and exposed parts are made of AISI 304 stainless steel, while the remaining components are made of AISI series 400 stainless steel.  
Only for the internal parts, such as combustion chambers and internal extractors, the AISI 430 stainless steel is used (we point out that, for internal parts, galvanized sheets is typically used).  
The ducts of gas main burners are obtained using stainless steel flexible pipes.  
Ignition, if any, takes place through a piezoelectric mechanical generator.

 Les plans de cuisson, les châssis et toutes les parties à vue sont réalisées en acier inox AISI 304. Le reste des éléments est en AISI series 400.  
A l'intérieur, dans des parties comme les chambres de combustion et les grilles d'évacuation, où pour la plupart du temps on trouve de la tôle zinguée, nous utilisons l'inox AISI 430.  
Les conduits gaz des brûleurs principaux sont réalisés en tube inox flexible.  
Si fourni, l'allumage est obtenu par générateur mécanique piézo.

 Die Kochflächen, die Armaturen Bretter und die sichtbaren Außenseiten, sind aus Edelstahl AISI 304 gefertigt, die restlichen Bauteile sind aus Edelstahl AISI series 400.  
Für die Innenteile, wie die Brennkammern und die Innen-Rauchabzüge wird AUSU 430 verwendet (für die Innenteile wird in der Regel verzinktes Blech verwendet).  
Die Gasleitungen der Primärbrenner sind aus einem flexiblen Edelstahl-Rohr gefertigt.  
Der Start geschieht, wo vorgesehen, über einen mechanischen Piezogenerator.

**Tutti i modelli sono disponibili, a richiesta, con maniglia inox blu scuro**

**All models are available, on request, with stainless steel dark blue handle**



# Friggitrici gas ed elettriche MacChef

## MacChef gas and electric fryers



Le friggitorie MacChef sono pensate per la semplicità di utilizzo e la produttività elevata grazie a particolari, frutto di ricerca e continuo dialogo con gli addetti ai lavori, assieme abbiamo cercato alcuni miglioramenti. Le dotazioni su queste macchine sono diverse e tutte utili per arrivare alla massima performance.

Sovrastruttura composta da un livello inclinato predisposto per l'inserimento di contenitori dotati di falso fondo forato, utili per contenere il prodotto da friggere ma anche per contenere il prodotto fritto, grazie al falso fondo forato il prodotto mantiene più a lungo la fragranza data dalla frittura ed anche la salatura può essere fatta direttamente dentro questi contenitori.



Nella parte superiore della sovrastruttura il piano superiore utilizzato come piano di appoggio alloggia nella parte inferiore un sistema a luce alogena (optional) che all'occorrenza serve a mantenere caldi i prodotti fritti sottostanti.

Il fronte operatore è dotato di un corrimano, utile ad appendere utensili e a proteggere l'operatore dal caldo sviluppato dall'olio all'interno delle vasche. Altro importante accessorio è il termometro analogico posto sul cruscotto che rileva la temperatura in tempo reale dell'olio in vasca, questo permette all'operatore di fare frittura perfette evitando di immergere i prodotti da friggere in vasca quando l'olio non è alla temperatura ottimale. La dotazione di serie prevede anche una vasca con filtro raccogli olio (per macchina) e il coperchio copri vasca ed un cestello grande per ogni vasca. **A richiesta disponibile la versione digitale.**



The MacChef fryers are designed for ease of use and high output thanks to in-depth research and continuous dialog with the workers, who helped us bring several improvements.

These machines feature different functions, created to achieve maximum performance.

The superstructure consists of a slanted surface prepared for the insertion of basins equipped with a false perforated bottom, designed to contain the product to be fried as well as the fried product. The false perforated bottom maintains the specific fry flavour of the product longer and the product can be salted directly in these basins.



In the upper part of the superstructure, the top board used as a bearing surface features, in its lower part, a halogen light system (optional) that can be used, when necessary, to keep warm the fried food below.

The front side is equipped with a rail useful to hang tools and to protect the operator from the heat generated by the oil inside the basins. Another important accessory is the analog thermometer on the control panel that measures the temperature of the oil in the basin in real time. This allows the operator to fry the products perfectly, without having to immerse the products in the basin when the oil is at optimal temperature.

The standard version also includes a basin with oil separation filter (per machine), a lid for the basin and a large basket for each basin. **Available on request the digital version.**



# Griglie dirette a gas MacChef

## Gas direct grill MacChef



Le griglie MacChef sono realizzate seguendo le esigenze di chi le utilizza, e sono pensate per avere la massima funzionalità ed essere performanti. Le grigliate di carne o pesce o verdure sono molto apprezzate dai commensali ma per chi si trova in cucina le problematiche sono diverse, incendio dei grassi e conseguente carbonizzazione dei cibi, che oltre a devastare la qualità finale è pure dannoso per la salute, continuo spostamento dei cibi in cottura per cercare di compensare alla scarsa uniformità di temperatura, difficoltà nel capovolgere gli alimenti specie se piccoli richiede tanto tempo e capita che spesso cadono sotto i piani di cottura.



Questi problemi MacChef li ha risolti con diverse innovazioni. La sovrastruttura è composta da un piano in tubo utile per appoggiare vassoi con prodotti da grigliare oppure grigliati mantenuti al caldo, il piano è totalmente smontabile, senza utilizzo di utensili per agevolare la pulizia dell'attrezzatura. Nella parte bassa posteriore della sovrastruttura vengono incernierati i coperchi, utilissimi per aumentare la resa della macchina e conseguentemente per cuocere più in fretta, in modo più uniforme e anche nella parte non a contatto con il piano di cottura, con questo sistema la cottura delle verdure viene ridotta del 30/40% e cosa ancora più importante grazie al vapore che viene prodotto nella vasca posta sotto i bruciatori i prodotti perdono meno peso e non si seccano. I piani per la grigliatura sono realizzati in lamiera inox e sono dotati di una sagomatura inferiore utile a contenere i grassi evitando l'effetto incendio il più possibile, nella parte inferiore le asolature asimmetriche aiutano l'aria calda ad emergere in maniera uniforme, il sistema realizzato in questo caso permette una cottura molto uniforme, e questo apre la strada ad una piccola serie di utensili per la cottura inutilizzabili su una griglia tradizionale.



MacChef grills are made according to the needs of the end user, and are designed to boast maximum functionality and performance. The grilled meat, fish or vegetables, are much appreciated by the diners, but for those in the kitchen the problems are different. If fat turns to fire, with consequent carbonization of foods, which, in addition to destroy the final quality of the food, is also harmful to health. Continuous move of food while cooking, trying to compensate for the poor temperature evenness, difficulties to turn over food, especially if small, is so time consuming and it often falls down under the hob.



These problems were solved by MacChef through several innovations. The superstructure consists of a tube board, useful to support trays with products to be grilled or already grilled but that must be maintained hot. The board can be fully removed without the aid of any tools, to easily clean the equipment. At the bottom rear part of the superstructure are hinged the lids, essential to increase the efficiency of the machine. When the lids are lowered, food can be cooked faster and more evenly, even in the area that does not come into contact with the hob. Therefore, this system reduces vegetable cooking time by 30-40% and, more important, thanks to the steam generated inside the basin fitted under the burners, the products lose less weight, and do not dry out. The grills are made in stainless steel sheet and feature a lower compartment useful to contain fats, thus avoiding fire as much as possible. The asymmetric slots located in the lower part help the hot air to be distributed evenly. In this case, the system allows a very even cooking, opening the way for a small series of cooking tools unusable on a traditional grill.





Gli utensili utilizzabili sulla griglia MacChef fanno risparmiare tantissimo tempo all'operatore, in un attimo si possono capovolgere 20 salsicce oppure 20 o 30 fettine di verdure, grazie al fatto che la cottura è uniforme non si è più costretti a cambiare posto agli alimenti, e con un semplice gesto i prodotti vengono cotti su entrambi i lati. Il fronte operatore è dotato di un corrimano, utile ad appendere utensili e a proteggere l'operatore dal caldo sviluppato.



Gli accessori MacChef per la cottura servono tutti allo stesso scopo, migliorare, facilitare e rendere più veloce il lavoro in cucina. Diversi tipi di fiancate assieme ai tubi per creare i livelli o i corrimano possono essere montate su tutte le nostre macchine standard per la cottura rendendo più semplice il lavoro con piani di appoggio aggiuntivi con corrimano dove appendere utensili in fase di utilizzo. I coperchi incernierati sulle sovrastrutture predisposte sono un valido aiuto alla riduzione dei tempi di cottura, alla riduzione di riscaldamento delle zone di cottura, alla protezione delle vasche da polvere e altri agenti contaminanti, e tutto questo con un coperchio che rimane anche quando non necessario sulla macchina senza essere di intralcio all'operatore, ma comunque estraibile per una sua facile pulizia. Tutti gli accessori MacChef sono a pag. 192 del listino.



The tools that can be used on MacChef grill saves plenty of time to the operator. Within a second, you can turn over 20 sausages or 20 or 30 slices of vegetables, thanks to the fact that cooking is even and you are no longer restricted to change the location of the products. With a simple gesture, the products are cooked on both sides. The front side features a rail, useful to hang tools and to protect the operator from the heat generated during cooking.



All MacChef cooking accessories serve the same purpose: enhance, facilitate and accelerate work in the kitchen. Different types of sides and the tubes create levels or the rails can be mounted on all of our standard cooking machines to ease work, with additional support boards with rails to hang the tools during cooking. The lids hinged to the preset superstructures are a real aid in reducing the cooking time, to heat generated by the cooking areas, in protecting the basins from dust and other contaminants. All this with a lid that remains fitted on the machine even when it is not necessary, without obstructing the operator. It can, however, be removed for easy cleaning. All MacChef accessories are at page 192 of price list.

### Friggitrici - griglie dirette a gas e elettriche / Gas and electric fryer - direct grill

CODICE CODE CODE ARTIKELNR	DESCRIZIONE DESCRIPTION DESCRIPTION BESCHREIBUNG	DIMENSIONI DIMENSIONS DIMENSIONS MAßE	KW KW KW KW	KW TOT KW TOT KW TOT KW TOT	GAS\ELET	V\HZ V\HZ V\HZ V\HZ	CAPACITÀ CAPACITY CAPACITY KAPAZITÄT
M7CFFG1SI M7CFFG2SI	friggitrice a gas gas fryer	400x700x900 800x700x900	14x1 14x2	14 28	g g		18 L 18x2 L
M7CFFE18 M7CFFE218	friggitrice elettrica electric fryer	400x700x900 800x700x900	14x1 14x2	14 28	e e	400\50 400\50	18 L 18x2 L
MCFFG1 MCFFG2	friggitrice a gas gas fryer	450x900x900 900x900x900	14x1 14x2	14 28	g g		18 L 21x2 L
MCFFE1 MCFFE2	friggitrice elettrica electric fryer	450x900x900 900x900x900	18x1 18x2	18 36	e e	400/50 400/50	18 L 21x2 L
M7CGG2AV M7CGG4AV M7CGG6AV	griglia diretta a gas vano a giorno griglia diretta a gas vano a giorno griglia diretta a gas vano a giorno	450x700x900 800x700x900 1200x700x900	9x1 9x2 9x3	9 18 27	g g g		365x460 730x460 1095x460
M9CGG2AV M9CGG4AV M9CGG6AV	griglia diretta a gas vano a giorno griglia diretta a gas vano a giorno griglia diretta a gas vano a giorno	450x900x900 800x900x900 1200x900x900	12,5x1 12,5x2 12,5x3	12,5 25 37,5	g g g		365x660 730x660 1095x660
MCGG2AV MCGG4AV MCGG6AV	griglia diretta a gas vano a giorno griglia diretta a gas vano a giorno griglia diretta a gas vano a giorno	520x900x900 900x900x900 1350x900x900	12,5x1 12,5x2 12,5x3	12,5 25 37,5	g g g		410x660 830x660 1245x660

# Cucine a fiamma libera forno a gas 700/900 - passo 400



Burners gas range with gas oven 700/900 - mm 400

Cuisinières avec feux vifs four à gaz 700/900 - bloc de 400

Herde mit offener Flamme Gasherde 700/900 - Breite 400



Il piano di lavoro è totalmente aperto per una facile pulizia e manutenzione. È predisposto per alloggiare dei traversi che sostengono le bacinelle stampate h. 65 che garantiscono la tenuta dei liquidi e servono da riscontro per posizionare la griglia poggia pentole in ghisa.

La bacinella inox è singola e di facile pulizia anche in lavastoviglie. Al di sotto del piano, al centro, sono inserite delle staffe in 4 mm che garantiscono la massima tenuta al peso senza pericolo di flessione.

Il forno statico GN 2/1 arriva a circa 280° ed è dotato di rubinetto con termostato ad 8 posizioni progettato in modo da offrire una migliore uniformità di temperatura.

L'invaso a passo è ricavato da stampo con bacinella estraibile.

- La griglia poggia pentole è singola
- L'accensione del forno è piezo elettrica
- Il cruscotto comandi è incassato per una migliore protezione



The worktop is totally exposed for easy cleaning and maintenance. It is designed to house the crosspieces that support the basins marked h. 65 which guarantee the sealing of liquids and serve as an abutment to position the cast iron grid holding the cookware.

The stainless steel basin is one-piece and easy to clean, even in the dishwasher. Below the worktop, at the centre, are 4 mm inserted brackets which ensure maximum load capacity, without any danger of bending.

The GN 2/1 convection oven reaches about 280° and is equipped with an 8-position thermostat tap designed to provide better temperature uniformity.

The recessed basin is created from a mould with an extractable basin.

- The grill trivet is separate
- The oven boasts piezo-electric starting
- The control panel is built-in for increased protection



Le plan de travail est entièrement ouvert pour un nettoyage facile et un entretien aisé. Préparé afin d'adapter des supports traversants pour bacs h. 65 mm qui garantissent leur tenue et bloquent la grille en fonte. Il s'agit d'un bac inox simple et facile à nettoyer qui passe aussi dans le lave-vaisselle. Au-dessous du plan, au centre, des barres de 4 mm donnent une garantie de tenue très élevée au poids sans risque de flexion.

Le four statique GN 2/1 atteint 280°C environ et il est fourni avec un robinet et thermostat à 8 positions étudié afin de donner une meilleure uniformité de température.

Le plan embouti est obtenu par moulage avec cuvette amovible.

- La grille pour appuyer les casseroles est individuelle
- Le four est doté d'allumage piézoélectrique
- Le panneau de commandes est encastré pour une protection accrue



Die Arbeitsfläche ist vollkommen offen, zur Erleichterung der Reinigungs- und Wartungsarbeiten.

Vorbereitet zur Aufnahme der Querbalken, die die gestanzten Mulden h.65 halten, sie garantieren die Dichtung der Flüssigkeit und dienen als Anschlag zur Positionierung des Topfstellrosts aus Gusseisen.

Reinigungsfreundliche Einzel-Edelstahlwanne, Spülmaschinenfest. Unter der Kochfläche, in der Mitte, sind 4 mm Bügel eingefügt, die maximalen Halt des Gewichtes, ohne Gefahr eines Verbiegens, garantieren.

Der statische Ofen GN 2/1 erreicht ungefähr 280°, mit Hahn mit Thermostat, mit 8 Positionen, zur Gewährleistung einer gleichmäßigen Temperatur.

Die formgepresste Wanne hat eine herausnehmbare Schale

- Es gibt ein Topfstellrost
- Der Ofen wird piezoelektrisch eingeschaltet
- Die Armaturen sind eingebaut, um eine höhere Sicherheit zu garantieren



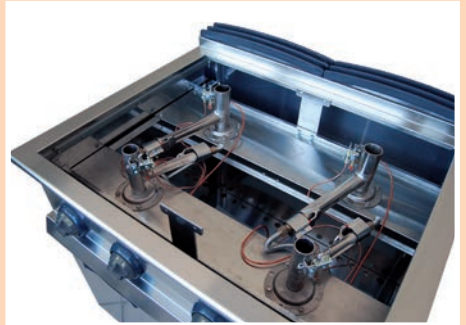

### Cucine a fiamma libera forno a gas 700

Burners gas range with gas oven 700

Cuisinières avec feux vifs et four à gaz 700

Herde mit offener Flamme Gasofen 700

CODICE CODE CODE ARTIKELNR	DESCRIZIONE DESCRIPTION DESCRIPTION BESCHREIBUNG	DIMENSIONI DIMENSIONS DIMENSIONS MAßE	KW G KW G KW G	KW M KW M KW M	KW P KW P KW P	KW FOR KW FOR KW FOR	KW TOT KW TOT KW TOT	CAPACITÀ CAPACITY CAPACITE KAPAZITÄT
7TFLG2/12	cucina fuochi aperti da banco burners gas top range	400x700x280	8,2x1	7x1	4,2x1		11,2	
7TFLG2P/12		400x700x280		4,2x1	12,4			
7TFLG2D/12		400x700x280		4,2x2	8,4			
7TFLG4/12		800x700x280	7x2	4,2x2	22,4			
7TFLG4P/12		800x700x280	8,2x1	7x2	4,2x1		26,4	
7TFLG4D/12		800x700x280	7x2	4,2x4	16,8			
7TFLG6/12		1200x700x280	7x3	4,2x3	33,6			
7TFLG6P/12		1200x700x280	8,2x2	7x2	4,2x2		38,8	
7TFLG6D/12	1200x700x280			4,2x6	25,2			
7CFLG2A/12	cucina fuochi aperti su base senza ante burners gas range on open base	400x700x900	8,2x1	7x1	4,2x1		11,2	
7CFLG2PA/12		400x700x900		4,2x1	12,4			
7CFLG2DA/12		400x700x900		4,2x2	8,4			
7CFLG4A/12		800x700x900	7x2	4,2x2	22,4			
7CFLG4PA/12		800x700x900	8,2x1	7x2	4,2x1		26,4	
7CFLG4DA/12		800x700x900	7x2	4,2x4	16,8			
7CFLG6A/12		1200x700x900	7x3	4,2x3	33,6			
7CFLG6PA/12		1200x700x900	8,2x2	7x2	4,2x2		38,8	
7CFLG6DA/12	1200x700x900			4,2x6	25,2			
7CFLG4FG/12	cucina fuochi aperti con forno gas burners gas range on gas oven	800x700x900	8,2x1	7x2	4,2x2	5x1	27,4	gn 2\1
7CFLG4FGP/12		800x700x900		7x2	4,2x1	5x1	31,4	gn 2\1
7CFLG4FGD/12		800x700x900		7x2	4,2x4	5x1	21,8	gn 2\1
7CFLG6FG/12		1200x700x900	7x3	4,2x3	5x1	38,6	gn 2\1	
7CFLG6FGP/12		1200x700x900	8,2x2	7x2	4,2x2	5x1	43,8	gn 2\1
7CFLG6FGD/12		1200x700x900			4,2x6	5x1	30,2	gn 2\1

### Cucine a fiamma libera forno a gas 900

Burners gas range with gas oven 900

Cuisinières avec feux vifs et four à gaz 900

Herde mit offener Flamme Gasofen 900

CODICE CODE CODE ARTIKELNR	DESCRIZIONE DESCRIPTION DESCRIPTION BESCHREIBUNG	DIMENSIONI DIMENSIONS DIMENSIONS MAßE	KW G KW G KW G	KW M KW M KW M	KW P KW P KW P	KW FOR KW FOR KW FOR	KW TOT KW TOT KW TOT	CAPACITÀ CAPACITY CAPACITE KAPAZITÄT
9TFLG2/12	cucina fuochi aperti da banco burners gas top range	400x900x280	9,2x1	7x1	4,2x1		11,2	
9TFLG2P/12		400x900x280		4,2x1	13,4			
9TFLG4/12		800x900x280		7x2	4,2x2		22,4	
9TFLG4P/12		800x900x280	9,2x1	7x2	4,2x1		27,4	
9TFLG6/12		1200x900x280	7x3	4,2x3	33,6			
9TFLG6P/12		1200x900x280	9,2x2	7x2	4,2x2		40,8	
9CFLG2A/12	cucina fuochi aperti su base senza ante burners gas range on open base	400x900x900	9,2x1	7x1	4,2x1		11,2	
9CFLG2PA/12		400x900x900		4,2x1	13,4			
9CFLG4A/12		800x900x900		7x2	4,2x2		22,4	
9CFLG4PA/12		800x900x900	9,2x1	7x2	4,2x1		27,4	
9CFLG6A/12		1200x900x900	7x3	4,2x3	33,6			
9CFLG6PA/12		1200x900x900	9,2x2	7x2	4,2x2		40,8	
9CFLG4FG/12	cucina fuochi aperti con forno gas burners gas range on gas oven	800x900x900	9,2x1	7x2	4,2x2	5x1	27,4	gn 2\1
9CFLG4FGP/12		800x900x900		7x2	4,2x1	5x1	32,4	gn 2\1
9CFLG6FG/12		1200x900x900	7x3	4,2x3	5x1	38,6	gn 2\1	
9CFLG6FGP/12		1200x900x900	9,2x2	7x2	4,2x2	5x1	45,8	gn 2\1

# Fiamme libere passanti



Open flames rings

Cuisinieres a gaz traversantes

Offene Flammen



Le fiamme libere passanti sono state realizzate per essere combinate con tutte le altre macchine standard come frytop, friggitrici, cuocipasta, etc... ottenendo così una composizione passante ad un ottimo prezzo senza nulla togliere alla qualità. Il piano di lavoro è totalmente aperto per una facile pulizia e manutenzione.

È predisposto per alloggiare dei traversi che sostengono le bacinelle stampate h. 65 che garantiscono la tenuta dei liquidi e servono da riscontro per posizionare la griglia poggia pentole in ghisa.

La bacinella inox è singola e di facile pulizia anche in lavastoviglie.

Al di sotto del piano, al centro, sono inserite delle staffe in 4 mm che garantiscono la massima tenuta al peso senza pericolo di flessione.

Il forno statico GN 2/1 arriva a circa 280° ed è dotato di rubinetto con termostato ad 8 posizioni progettato in modo da offrire una migliore uniformità di temperatura.



Open flames rings are designed to be combined with all other standard machines as fry tops, fryers, pasta-cookers, etc... thus obtaining a versatile composition at a great price, without sacrificing quality.

The worktop is totally exposed for easy cleaning and maintenance.

It is designed to house the crosspieces that support the basins marked h. 65 which guarantee the sealing of liquids and serve as an abutment to position the cast iron grid holding the cookware. The stainless steel basin is one-piece and easy to clean, even in the dishwasher.

Below the worktop, at the centre, are 4 mm inserted brackets which ensure maximum load capacity, without any danger of bending.

The GN 2/1 convection oven reaches about 280° and is equipped with an 8-position thermostat tap designed to provide better temperature uniformity.



Les cuisinières à gaz traversantes ont été étudiées afin d'être combinées avec toutes les autres machines standards comme les fry-top, les friteuses, les cuiseurs de pâtes, etc... ayant ainsi une solution traversante à un prix très intéressant sans risque d'affectation de la qualité.

Le plan de travail est entièrement ouvert pour un nettoyage facile et un entretien aisé.

Préparé afin d'adapter des supports traversants pour bacs h. 65 mm qui garantissent leur tenue et bloquent la grille en fonte.

Il s'agit d'un bac inox simple et facile à nettoyer qui passe aussi dans le lave-vaisselle.

Au-dessous du plan, au centre, des barres de 4 mm donnent une garantie de tenue très élevée au poids sans risque de flexion.

Le four statique GN 2/1 atteint 280°C environ et il est fourni avec un robinet et thermostat à 8 positions étudié afin de donner une meilleure uniformité de température.



Die offenen Durchgangsflamme wurden geschaffen, um mit allen Standardgeräten kombiniert werden zu können, wie Frytop, Fritteuse, Nudelkocher, usw. ... man erhält so eine Durchgangskomposition zu einem ausgezeichneten Preis, bei optimaler Qualität.

Die Arbeitsfläche ist vollkommen offen, zur Erleichterung der Reinigungs- und Wartungsarbeiten.

Vorbereitet zur Aufnahme der Querbalken, die die gestanzten Mulden h.65 halten, sie garantieren die Dichtung der Flüssigkeit und dienen als Anschlag zur Positionierung des Topfstellrosts aus Gusseisen.

Reinigungsfreundliche Einzel-Edelstahlwanne, Spülmaschinenfest.

Unter der Kochfläche, in der Mitte, sind 4 mm Bügel eingefügt, die maximalen Halt des Gewichtes, ohne Gefahr eines Verbiegens, garantieren.

Der statische Ofen GN 2/1 erreicht ungefähr 280°, mit Hahn mit Thermostat, mit 8 Positionen, zur Gewährleistung einer gleichmäßigen Temperatur.





# Fiamme libere passanti



Open flames rings

Cuisinieres a gaz traversantes

Offene Flammen



## Cucine a fiamma libera forno a gas passanti

Burners gas range with gas oven

Cuisinières avec feux vifs et four à gaz

Herde mit offener Flamme Gasofen

CODICE CODE CODE ARTIKELNR	DESCRIZIONE DESCRIPTION DESCRIPTION BESCHREIBUNG	DIMENSIONI DIMENSIONS DIMENSIONS MAßE	KW G KW G KW G	KW M KW M KW M	KW P KW P KW P	KW FOR KW FOR KW FOR	KW TOT KW TOT KW TOT	CAPACITÀ CAPACITY CAPACITÄT
10PCFLG2A/12	cucina fuochi aperti passante senza ante burners gas range pass-through on open base	400x1000x900	8,2x2	7x2			14	
10PCFLG2PA/12		400x1000x900		7x4			16,4	
10PCFLG4A/12		900x1000x900	8,2x4	7x4			28	
10PCFLG4PA/12		900x1000x900		7x6			32,8	
10PCFLG6A/12		1300x1000x900	8,2x6	7x6			42	
10PCFLG6PA/12	1300x1000x900			49,2				
10PCFLG4FG/12	cucina fuochi aperti passante+forno gas burners gas range pass-through on oven	900x1000x900	8,2x4	7x4		5x1	33	gn 2\1
10PCFLG4FGP/12		900x1000x900		7x6		37,8		
10PCFLG6FG/12		1300x1000x900	8,2x6	7x6		5x1	47	gn 2\1
10PCFLG6FGP/12		1300x1000x900				54,2	gn 2\1	
12PCFLG2A/12	cucina fuochi aperti passante senza ante burners gas range pass-through on open base	400x1200x900	9,2x2	7x2			14	
12PCFLG2PA/12		400x1200x900		7x4			18,4	
12PCFLG4A/12		900x1200x900	9,2x4	7x4			28	
12PCFLG4PA/12		900x1200x900		7x6			36,8	
12PCFLG6A/12		1300x1200x900	9,2x6	7x6			42	
12PCFLG6PA/12	1300x1200x900			55,2				
12PCFLG4FG/12	cucina fuochi aperti passante+forno gas burners gas range pass-through on oven	900x1200x900	9,2x4	7x4		5x1	33	gn 2\1
12PCFLG4FGP/12		900x1200x900		7x6		5x1	41,8	gn 2\1
12PCFLG6FG/12		1300x1200x900	9,2x6	7x6		5x1	47	gn 2\1
12PCFLG6FGP/12		1300x1200x900				5x1	60,2	gn 2\1

# Friggitrici gas e elettriche 700/900 - passo 400/450



Gas and electric fryer 700/900 - mm 400/450

Friteuses à gaz et électriques 700/900 - bloc de 400/450

Elektro und Gas Friteuse 700/900 - Breite 400/450



Invaso a passo con scivolo anteriore realizzato tramite stampaggio. Capacità per singola vasca lt.18 sia per versione a gas che elettrica. Disponibile vasca raccogli olio con filtro. La valvola è di tipo meccanico senza necessità di connessione elettrica. Le vasche da lt. 18 e 21 a gas hanno gli scambiatori in vasca per avere la massima potenza in minor tempo. Adatto per alta produttività. La versione elettrica è dotata di resistenza in vasca a bandiera. Versione digitale permette di impostare un differenziale di accensione anche di un solo grado per avere una macchina più reattiva. Presente la funzione melting che prevede una temperatura di preriscaldamento e mantenimento per avere la macchina sempre pronta.



Recessed basin with sliding front created by moulding. 18lt capacity for a single recess for both gas and electric versions. An oil collecting vessel with a filter is available. The valve is of the mechanical type and it does not require electrical connection. The heat exchangers of the 18 and 21 litre gas version are in the recess for maximum power within the shortest amount of time. Designed for high productivity. The electric version is equipped with a hot plate in the recess tank with top-mounted heater. Digital version allows you to set a single-degree ignition differential to have a more reactive machine. There is a melting function that provides a preheating and maintenance temperature for the machine to be ready.



Friggitrici gas e elettriche / Gas and electric fryer / Friteuses à gaz et électriques / Elektro und Gas Friteuse

CODICE CODE CODE ARTIKELNR	DESCRIZIONE DESCRIPTION DESCRIPTION BESCHREIBUNG	DIMENSIONI DIMENSIONS DIMENSIONS MAßE	KW KW KW	KW TOT KW TOT KW TOT	GAS/ELET	V\HZ V\HZ V\HZ	CAPACITÀ CAPACITY CAPACITE KAPAZITÄT
7CFFG1SI 7CFFG2SI 7CFFG288	friggitrice a gas gas fryer	400x700x900 800x700x900 400x900x900	14x1 14x2 6x2	14 28 12	g g g		18 L 18x2 L 8x2 L
7CFFE18 7CFFE218 7CFFE288	friggitrice elettrica electric fryer	400x700x900 800x700x900 400x900x900	14x1 14x2 7x2	14 14+14 14	e e e	400/50 400/50 400/50	18 L 18x2 L 8x2 L
9CFFG1SI 9CFFG2SI 9CFFG288	friggitrice a gas gas fryer	400x900x900 800x900x900 800x900x900	14x1 14x2 6x2	14 28 12	g g g		18 L 18x2 L 8x2 L
9CFFE18 9CFFE218 9CFFE288	friggitrice elettrica electric fryer	400x900x900 800x900x900 800x900x900	14x1 14x2 7x2	14 14+14 14	e e e	400/50 400/50 400/50	18 L 18x2 L 8x2 L
CFFG1 CFFG2 FRGP45	friggitrice a gas gas fryer	450x900x900 900x900x900 800x730x900	14x1 14x2 14x2	14 28 28	g g g		18 L 21x2 L 45 L
CFFE1 CFFE2	friggitrice elettrica electric fryer	450x900x900 900x900x900	18x1 18x2	18 18+18	e e	400/50 400/50	18 L 21x2 L
7CFFG1D 9CFFG1D 7CFFG2D 9CFFG2D	friggitrice a gas digitale digital gas fryer	400x700x900 400x900x900 800x700x900 800x900x900	14x1 14x1 14x2 14x2	14 14 28 28	g g g g		18 L 18 L 18x2 L 18x2 L
7CFFE18D 9CFFE18D 7CFFE218D 9CFFE218D	friggitrice elettrica digitale digital electric fryer	400x700x900 400x900x900 800x700x900 800x900x900	14x1 14x1 14x2 14x2	14 14 14+14 14+14	e e e e	400/50 400/50 400/50 400/50	18 L 18 L 18x2 L 18x2 L

# Cuocipasta gas e elettrici 700/900 - passo 400



Gas and electric pasta cookers 700/900 - mm 400

Cuiseurs de pâtes à gaz ou électriques 700/900 - bloc de 400

Elektro und Gas Nudelkocher 700/900 - Breite 400



La vasca ha una capacità nominale di 28 litri per serie 700 e 40 litri per serie 900 ed è completa di falso fondo inferiore ed anteriore e gruppo carico/scarico acqua. La versione a gas viene riscaldata dal bruciatore posto sotto la vasca mentre la versione elettrica è dotata di resistenza corazzata posta all'interno della vasca sotto il falso fondo inferiore. Versione gas potenziata utile per la massima velocità macchina e avere maggior spunto quando viene reintrodotta la materia prima. Nella versione elettrica è disponibile anche il bagnomaria. Sia la versione a gas che quella elettrica, sono dotate di termostato di sicurezza.



The tank has a rated capacity of 28 litres for the 700 series and 40 litres for the 900 series. It includes a false bottom in the lower front section and a water intake/discharge. The gas version is heated by a burner located under the recess while the electric version is equipped with an electric immersion heater. Powerful gas version useful for maximum machine speed and get the most out of it when the raw material is reintroduced. This heater is located inside the recess, under the false bottom in the lower section. A bain-marie is also available for the electric version. Both the gas and electric versions, are equipped with safety thermostat.



Le bac a une capacité nominale de 28 litres pour la série 700 et de 40 litres sur la série 900 et elle est équipée d'un faux-fond inférieur et antérieur ainsi que d'un groupe de remplissage/vidange de l'eau. Le réchauffement sur la version à gaz est obtenu grâce au brûleur situé sous la cuve alors que la version électrique est dotée de résistance blindée située à l'intérieur de la cuve, sous le faux-fond inférieur. Version équipée du moteur à gaz utile pour voiture grande vitesse quand il est réintroduit à la matière première. L'option bain-marie est également disponible dans la version électrique. Les deux versions, gaz aussi bien que électrique, ont un thermostat de sécurité.



Die Wanne hat eine Nennkapazität von 28 Litern für 700-Serie, die Serie 900 eines von 40 Litern und verfügt über einen unteren Zwischenboden und eine Wasserbefüll- und -ablassanlage. Die Gasversion wird durch einen Brenner, der sich unter dem Becken befindet, beheizt, während die Elektroversion einen gepanzerten Widerstand hat, der unter dem Zwischenboden liegt. Gasbetriebsversion, die für High-Speed ,auto und hat mehr Inspiration, wenn es um den Rohstoff wieder eingeführt wird. Die Elektroversion ist auch mit Wasserbad erhältlich. Sowohl die Gasausführung, als auch die elektrische Ausführung, sind mit Sicherheitsthermostat versehen.





La vasca è realizzata in AISI 316 per garantirne la maggior durata nel tempo.

- Il gruppo erogatore ed il troppo pieno sono posti sotto il falso fondo anteriore.
- L'invaso è profondo 50 mm per contenere il più possibile i liquidi in fase di ebollizione.



The tank it's made in AISI 316 to guarantee better length of time.

- Distributor group and overflow are placed under front false bottom.
- Recess on top is 50 mm deep to contain more liquid possible in boiling phase.



Le bac est fabriqué en AISI 316 afin d'en garantir une durée prolongée dans le temps.

- Le groupe de chargement et le tube surverse sont situés sous le faux fond antérieur.
- Le bord du plan a une profondeur de 50 mm afin de contenir les liquides au maximum pendant la phase d'ébullition.



Das Becken ist ganz aus rostfreiem AISI 316 Edelstahl gebaut, um eine längere Lebensdauer zu garantieren.

- Die Versorgungsgruppe und der Auslass befinden sich auf der Hinterseite des Zwischenbeckens.
- Der Fassungsvermögen ist 50 mm tief, damit die kochenden Flüssigkeiten besser enthalten werden kann.



Sollevatori cestelli a richiesta

**Cuocipasta gas e elettrici / Gas and electric pasta cookers / Cuisseurs de pâtes à gaz ou électriques / Elektro und Gas Nudelkocher**

CODICE CODE CODE ARTIKELNR	DESCRIZIONE DESCRIPTION DESCRIPTION BESCHREIBUNG	DIMENSIONI DIMENSIONS DIMENSIONS MAßE	KW G KW G KW G	KW TOT KW TOT KW TOT	V\HZ V\HZ V\HZ	CAPACITÀ CAPACITY CAPACITE KAPAZITÄT
7CCPG1 7CCPG2	cuocipasta a gas gas pasta cooker	400x700x900 800x700x900	9,8x1 9,8x2	9,8 19,6		28 L 28x2 L
7CCPE1 7CCPE2	cuocipasta elettrico electric pasta cooker	400x700x900 800x700x900	6,2x1 6,2x2	6,2 12,4	400\50 400\50	28 L 28x2 L
9CCPG1 9CCPG2	cuocipasta a gas gas pasta cooker	400x900x900 800x900x900	12,2x1 12,2x2	12,2 24,4		40 L 40x2 L
9CCPG1P 9CCPG2P	cuocipasta a gas potenziato gas pasta cooker boosted	400x900x900 800x900x900	14x1 14x2	14 28		40 L 40x2 L
9CCPE1 9CCPE2	cuocipasta elettrico electric pasta cooker	400x900x900 800x900x900	9,2x1 9,2x2	9,2 18,4	400\50 400\50	40 L 40x2 L

**Sollevatori cestelli automatici elettrici**

MSAP287	sollevatore 2 cestelli	100x700x900		0,15	230/50	
MSAP389	sollevatore 3 cestelli	100x900x900		0,2	230/50	

**Bagnomaria elettrici / Electric bain-maries / Bain-marie électriques / Elektro Wasserbad**

7CBME1A	bagnomaria elettrico / electric bain-marie	400x700x900	0,5x1	0,5	230\50	gn 2/3
9CBME1A	bagnomaria elettrico / electric bain-marie	400x900x900	0,5x2	1	230\50	gn 1/1

# Fry top elettrici e gas 700/900 - passo 400/450



Gas and electric fry-tops 700/900 - mm 400/450

Plaques électriques et à gaz 700/900 - bloc de 400/450

Elektro oder Gas Fry Top 700/900 - Breite 400/450



Le piastre, in tutte le versioni, sono realizzate in acciaio spessore 15 mm e, durante il funzionamento, controllate da rubinetto termostato da 8 posizioni, temperatura massima 250/280°C. La zona di cottura ha una buona uniformità di temperatura e si espande per tutta la dimensione della piastra. La piastra nella parte anteriore è dotata di un canale raccogli grassi. Tutte le versioni, a richiesta, possono essere realizzate con piastra rivestita al cromo duro. Nelle versioni con piastra cromata e in tutte le versioni elettriche viene montato un termostato di sicurezza. Smontando il cruscotto esterno è tutto a portata di mano e tutti i componenti si possono sostituire dal lato anteriore della macchina. Il cassetto raccogli liquidi estraibile permette di fare velocemente le operazioni di pulizia.



In all versions plates are made from 15mm thick steel. During operation the plates are controlled by an 8-position thermostatic tap with a maximum temperature of 250/280°C. The cooking area has efficient temperature uniformity and extends to the entire area of the plate. The front part of the plate is equipped with a fat collecting channel. All versions can be created with a hard chrome cover upon request. The versions with chrome hot plates and all electric ones are fitted with a safety thermostat. Taking apart the external panel it's all handy and all the components can be replaced from the front side of the machine. The extractable drawer that collects liquids allows to make quickly cleaning's operations.



Dans toutes les versions, les plaques sont fabriquées en acier d'une épaisseur de 15 mm et, pendant le fonctionnement, elles sont contrôlées par un robinet thermostatique de 8 positions, température maximale de 250/280°C. La zone de cuisson présente une température homogène, qui se répand sur toute la surface de la plaque. La partie avant de la plaque est dotée d'une goulotte de récupération des graisses. Sur demande, toutes les versions peuvent être fabriquées avec une plaque revêtue de chrome dur. Dans les versions avec plaque chromée et dans toutes les versions électriques un thermostat de sécurité est montée en usine. Après avoir enlevé le châssis extérieur toutes les pièces peuvent être rejointes facilement et remplacées sur le côté avant de la machine. Le tiroir de collecte de la graisse extractible rend le nettoyage très rapide.



Die Herdplatten aller Versionen bestehen aus Stahl bei einer Dicke von 15mm, die während des Gebrauches über einen Temperatur-Knopfregler mit 8 Positionen geregelt werden. Die maximale Temperatur beträgt 250/280°C. Die Kochfläche verfügt über eine gute Temperaturuniformität, die sich über die gesamte Platte erstreckt. Die Platte hat an der Unterseite einen Sammelkanal für Fett. Auf Anfrage können alle Versionen mit einer Hartchrombeschichtung ausgestattet werden. In den Ausführungen mit verchromter Platte, wie in beiden elektrischen Ausführungen, wird ein Sicherheitsthermostat montiert. Durch die Abmontierung des äußeren Skeletts, kann man alle Komponente leicht, aus der Maschinenseite aus, ersetzen. Das Flüssigkeitssammlungsschublade ist abziehbar und erlaubt eine schnelle Säuberung.



La versione base, all'interno della Comunità Europea, non può essere utilizzata a contatto con gli alimenti (D.M. 21/03/1973, Reg CE 1935/2004)  
The basic version, within European Community, cannot be used in contact with food (D.M. 21/03/1973, Reg CE 1935/2004)

A richiesta piastra di cottura frytop realizzata in Aisi 430  
On demand frytop plate made in Aisi 430

Fry top elettrici e gas passo 400 / Gas and electric fry / Plaques électriques et à gaz / Elektro oder Gas Fry Top

CODICE CODE CODE ARTIKELNR	DESCRIZIONE DESCRIPTION DESCRIPTION BESCHREIBUNG	DIMENSIONI DIMENSIONS DIMENSIONS MAßE	KW KW KW KW	KW TOT KW TOT KW TOT KW TOT	V\HZ V \HZ V \HZ V \HZ	CAPACITÀ CAPACITY CAPACITE KAPAZITÄT
7CFTG2LA 7CFTG4LA	fry top gas piastra liscia vano giorno gas fry top smooth plate on open base	400x700x900 800x700x900	6x1 6x2	6 12		400x500 800x500
7CFTG2LRA 7CFTG4LRA	fry top gas piastra liscia/rigata vano giorno gas fry top smooth/ribbed plate on open base	400x700x900 800x700x900	6x1 6x2	6 12		400x500 800x500
7CFTG2RA 7CFTG4RA	fry top gas piastra rigata vano giorno gas fry top ribbed plate on open base	400x700x900 800x700x900	6x1 6x2	6 12		400x500 800x500
7TFTG2L 7TFTG4L	fry top gas piastra liscia da appoggio gas fry top top range smooth plate	400x700x280 800x700x280	6x1 6x2	6 12		400x500 800x500
7TFTG2LR 7TFTG4LR	fry top gas piastra liscia/rigata da appoggio gas fry top top range smooth/ribbed plate	400x700x280 800x700x280	6x1 6x2	6 12		400x500 800x500
7TFTG2R 7TFTG4R	fry top gas piastra rigata da appoggio gas fry top top range ribbed plate	400x700x280 800x700x280	6x1 6x2	6 12		400x500 800x500
7CFTE1LA 7CFTE2LA	fry top elettrico piastra liscia vano giorno electric fry top smooth plate on open base	400x700x900 800x700x900	5,4x1 5,4x2	5,4 10,8	400/50 400/50	400x500 800x500
7TFTE1 7TFTE2	fry top elettrico piastra liscia top da appoggio electric fry top top range smooth plate	400x700x280 800x700x280	5,4x1 5,4x2	5,4 10,8	400/50 400/50	400x500 800x500
7CFTE1LRA 7CFTE2LRA	fry top elettrico piastra liscia/rigata vano giorno electric fry top smooth/ribbed plate on open base	400x700x900 800x700x900	5,4x1 5,4x2	5,4 10,8	400/50 400/50	400x500 800x500
7TFTE1LR 7TFTE2LR	fry top elettrico piastra liscia/rigata top da appoggio electric fry top top range smooth/ribbed plate	400x700x280 800x700x280	5,4x1 5,4x2	5,4 10,8	400/50 400/50	400x500 800x500
7CFTE1RA 7CFTE2RA	fry top elettrico piastra rigata vano giorno electric fry top ribbed plate on open base	400x700x900 800x700x900	5,4x1 5,4x2	5,4 10,8	400/50 400/50	400x500 800x500
7TFTE1R 7TFTE2R	fry top elettrico piastra rigata top da appoggio electric fry top top range ribbed plate	400x700x280 800x700x280	5,4x1 5,4x2	5,4 10,8	400/50 400/50	400x500 800x500
9CFTG2LA 9CFTG4LA	fry top gas piastra liscia vano giorno gas fry top smooth plate on open base	400x900x900 800x900x900	9x1 9x2	9 18		400x700 800x700
9TFTG2L 9TFTG4L	fry top gas piastra liscia top da appoggio gas fry top top range smooth plate	400x900x280 800x900x280	9x1 9x2	9 18		400x700 800x700
9CFTG2LRA 9CFTG4LRA	fry top gas piastra liscia/rigata vano giorno gas fry top smooth/ribbed plate on open base	400x900x900 800x900x900	9x1 9x2	9 18		400x700 800x700
9TFTG2LR 9TFTG4LR	fry top gas piastra liscia/rigata top da appoggio gas fry top top range smooth/ribbed plate	400x900x280 800x900x280	9x1 9x2	9 18		400x700 800x700
9CFTG2RA 9CFTG4RA	fry top gas piastra rigata vano giorno gas fry top ribbed plate on open base	400x900x900 800x900x900	9x1 9x2	9 18		400x700 800x700
9TFTG2R 9TFTG4R	fry top gas piastra rigata top da appoggio gas fry top top range ribbed plate	400x900x280 800x900x280	9x1 9x2	9 18		400x700 800x700
9CFTE1LA 9CFTE2LA	fry top elettrico piastra liscia vano giorno electric fry top smooth plate on open base	400x900x900 800x900x900	7,5x1 7,5x2	7,5 15	400/50 400/50	400x700 800x700
9TFTE1L 9TFTE2L	fry top elettrico piastra liscia top da appoggio electric fry top top range smooth plate	400x900x280 800x900x280	7,5x1 7,5x2	7,5 15	400/50 400/50	400x700 800x700
9CFTE1LRA 9CFTE2LRA	fry top elettrico piastra liscia/rigata vano giorno electric fry top smooth/ribbed plate on open base	400x900x900 800x900x900	7,5x1 7,5x2	7,5 15	400/50 400/50	400x700 800x700
9TFTE1LR 9TFTE2LR	fry top elettrico piastra liscia/rigata top da appoggio electric fry top top range smooth/ribbed plate	400x900x280 800x900x280	7,5x1 7,5x2	7,5 15	400/50 400/50	400x700 800x700
9CFTE1RA 9CFTE2RA	fry top elettrico piastra rigata vano giorno electric fry top ribbed plate on open base	400x900x900 800x900x900	7,5x1 7,5x2	7,5 15	400/50 400/50	400x700 800x700
9TFTE1R 9TFTE2R	fry top elettrico piastra rigata top da appoggio electric fry top top range ribbed plate	400x900x280 800x900x280	7,5x1 7,5x2	7,5 15	400/50 400/50	400x700 800x700

Fry top elettrici e gas / Gas and electric fry / Plaques électriques et à gaz / Elektro oder Gas Fry Top

CODICE CODE CODE ARTIKELNR	DESCRIZIONE DESCRIPTION DESCRIPTION BESCHREIBUNG	DIMENSIONI DIMENSIONS DIMENSIONS MAßE	KW KW KW KW	KW TOT KW TOT KW TOT KW TOT	V\HZ V \HZ V \HZ V \HZ	CAPACITÀ CAPACITY CAPACITE KAPAZITÄT
CFTG2LA CFTG4LA	fry top gas piastra liscia vano giorno gas fry top smooth plate on open base	450x900x900 900x900x900	9x1 9x2	9 18		450x700 900x700
TFTG2L TFTG4L	fry top gas piastra liscia top da appoggio gas fry top top range smooth plate	450x900x900 900x900x900	9x1 9x2	9 18		450x700 900x700
CFTG2LRA CFTG4LRA	fry top gas piastra liscia/rigata vano giorno gas fry top smooth/ribbed plate on open base	450x900x900 900x900x900	9x1 9x2	9 18		450x700 900x700
TFTG2LR TFTG4LR	fry top gas piastra liscia/rigata top da appoggio gas fry top top range smooth/ribbed plate	450x900x900 900x900x900	9x1 9x2	9 18		450x700 900x700
CFTG2RA CFTG4RA	fry top gas piastra rigata vano giorno gas fry top ribbed plate on open base	450x900x900 900x900x900	9x1 9x2	9 18		450x700 900x700
TFTG2R TFTG4R	fry top gas piastra rigata top da appoggio gas fry top top range ribbed plate	450x900x900 900x900x900	9x1 9x2	9 18		450x700 900x700
CFTE1LA CFTE2LA	fry top elettrico piastra liscia vano giorno electric fry top smooth plate on open base	450x900x900 900x900x900	7,5x1 7,5x2	7,5 15	400/50 400/50	450x700 900x700
TFTE1L TFTE2L	fry top elettrico piastra liscia top da appoggio electric fry top top range smooth plate	450x900x900 900x900x900	7,5x1 7,5x2	7,5 15	400/50 400/50	450x700 900x700
CFTE1LRA CFTE2LRA	fry top elettrico piastra liscia/rigata vano giorno electric fry top smooth/ribbed plate on open base	450x900x900 900x900x900	7,5x1 7,5x2	7,5 15	400/50 400/50	450x700 900x700
TFTE1LR TFTE2LR	fry top elettrico piastra liscia/rigata top da appoggio electric fry top top range smooth/ribbed plate	450x900x900 900x900x900	7,5x1 7,5x2	7,5 15	400/50 400/50	450x700 900x700
CFTE1RA CFTE2RA	fry top elettrico piastra rigata vano giorno electric fry top ribbed plate on open base	450x900x900 900x900x900	7,5x1 7,5x2	7,5 15	400/50 400/50	450x700 900x700
TFTE1R TFTE2R	fry top elettrico piastra rigata top da appoggio electric fry top top range ribbed plate	450x900x900 900x900x900	7,5x1 7,5x2	7,5 15	400/50 400/50	450x700 900x700

PER TUTTI I FRY-TOP VERSIONE CROMATA (CR) STESSA CARATTERISTICHE

# Teppanyaki a gas



## Gas Teppanyaki



La piastra Teppanyaki è una piastra di grandi dimensioni adatta per la cottura di carne, pesce e verdure utilizzata nella Cottura Etnica.

La piastra di cottura liscia è disponibile sia in AISI 430 che in versione cromata, spessore 12 mm.

La versione cromata ad alta conducibilità termica, facilmente pulibile a basso livello di irraggiamento evita inutili e fastidiose dispersioni di calore nell'ambiente.

La versione in ferro invece è indicata per avere un più alto irraggiamento in fase di cottura, indicata per prodotto di alto spessore o per prodotti come la piadina romagnola.

L'uniformità di temperatura in cottura è garantita nell'area coperta dai due bruciatori per lunghezza 1200 e 3 bruciatori per il 1600 ad alto rendimento, canalina frontale con foro di scarico e cassetto raccolta residui cottura, temperatura approssimativa di funzionamento 160°-280 °C.

Non componibile con cottura 700/900.



The Teppanyaki grill is a large griddle plate suitable for cooking meat, fish and vegetables used in ethnic cuisine.

The flat grill is available in both AISI 430 and chrome plated versions with a thickness of 12 mm.

The chrome plated version has high thermal conductivity, is easy to clean and its low radiation avoids unnecessary and bothersome heat loss.

On the other hand, the iron version is suitable when a higher radiation is needed, for thicker products or products such as the piadina.

Cooking temperature uniformity is ensured for a length of 1200 with two high efficiency burners and for 1600 with 3 burners, front channel with drain hole and grease collection drawer, approximate working temperature 160°-280 °C.

No modular with series 700/900.

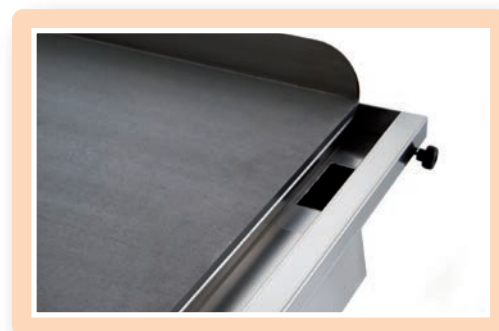

### Teppanyaki a gas piastra liscia Gas Teppanyaki smooth plate

CODICE CODE CODE ARTIKELNR	DESCRIZIONE DESCRIPTION DESCRIPTION BESCHREIBUNG	DIMENSIONI DIMENSIONS DIMENSIONS MABE	KW TOT KW TOT KW TOT KW TOT
TE1200/FE	teppanyaki a gas piastra liscia AISI 430 / gas teppanyaki smooth plate	1230x750x900	14
TE1200	teppanyaki a gas piastra liscia CROMATA / gas teppanyaki smooth plate	1230x750x900	14
TE1600/FE	teppanyaki a gas piastra liscia AISI 430 / gas teppanyaki smooth plate	1630x750x900	17,6
TE1600	teppanyaki a gas piastra liscia CROMATA / gas teppanyaki smooth plate	1630x750x900	17,6

# Cucine elettriche 700/900 - passo 400/450

Electric range 700/900 - mm 400/450

Cuisinières électriques 700/900 - bloc de 400/450

Elektroherd 700/900 - Breite 400/450



Ampla disponibilità di gamma, dal vetroceramica alla piastra singola in ghisa con e senza forno.

Forno elettrico statico con funzione grill GN 2/1 - KW 5,1 per serie 700 e KW 6 per serie 900 - raggiunge una temperatura di 280°C.

Le piastre in ghisa sono tonde ø mm 220 per serie 700 e quadre 220x220 per serie 900 passo 400 e quadre 300x300 per serie 900 passo 450.

Il vetroceramica è dotato di sensore caldo residuo per garantire una maggior sicurezza dell'operatore.



Wide range available, from glass-ceramic to individual, cast iron plates with or without an oven.

Static electric oven with a GN 2/1 grill function. This is 5.1 KW for the 700 series and 6KW for the 900 series and reaches a temperature of 280°C.

Cast iron plates are circular - 220mm - for the 700 series and square - 220x200mm for the 900 series block 400 and square 300x300 for 900 series block 450.

Glass-ceramic plates are equipped with residual heat sensors to ensure greater safety for the user.



La gamme disponible est très vaste, de la version vitrocéramique à la plaque individuelle en fonte avec ou sans four.

Le four électrique statique avec fonction grill GN 2/1 - 5,1 kW pour la série 700 et 6 kW pour la série 900 - atteint une température de 280°.

Les plaques en fonte sont rondes de 220 mm. pour la série 700 et carrées de 220x220 pour la série 900 bloc de 400 et carrées de 300x300 pur la série 900 bloc de 450.

La version vitrocéramique est dotée d'un capteur de chaleur résiduelle pour garantir une plus grande sécurité à l'opérateur.



Große Produktvielfalt, von der Glaskeramik bis zur einzelnen Herdplatte aus Gusseisen mit oder ohne Ofen.

Statischer Elektroofen mit Grillfunktion GN 2/1 - KW 5,1 für die Serie 700 und 6 KW für die Serie 900 - erreicht eine Temperatur von 280°C.

Die Gusseisenherdplatten der Serie 700 sind rund bei einem Durchmesser von 220mm und quadratisch bei der Serie 900 (220x220mm). Uno quadratisch 300x300 bei der Serie 900 breite 450. Die Glaskeramik ist mit einem Restwärmesensor

ausgestattet, um dem Bediener eine höhere Sicherheit zu garantieren.





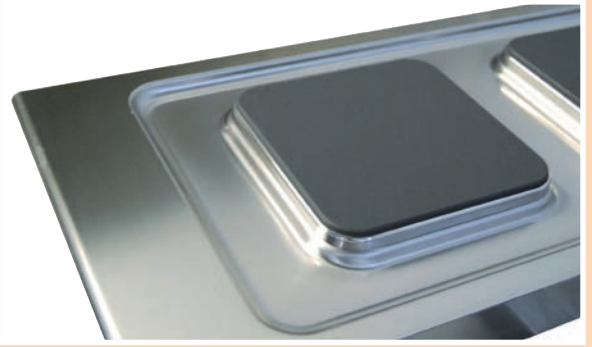
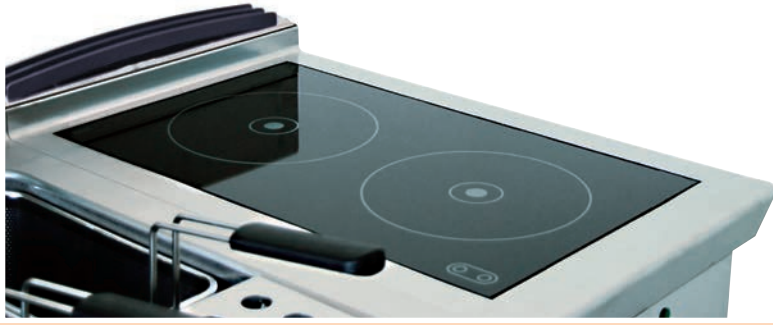

**Cucine elettriche / Electric range / Cuisinières électriques / Elektroherd**

<b>CODICE</b> CODE CODE ARTIKELNR	<b>DESCRIZIONE</b> DESCRIPTION DESCRIPTION BESCHREIBUNG	<b>DIMENSIONI</b> DIMENSIONS DIMENSIONS MAßE	<b>KW</b> KW KW KW	<b>KW FORNO</b> KW OVEN KW FOUR KW OFEN	<b>KW TOT</b> KW TOT KW TOT KW TOT	<b>V\HZ</b> V\HZ V\HZ V\HZ	<b>CAPACITÀ</b> CAPACITY CAPACITE KAPAZITÄT
7CPSE1A 7CPSE2A	cucina a piastre elettriche base a giorno electric single plates range on open base	400x700x900 800x700x900	2,6x2 2,6x4		5,2 10,4	400\50 400\50	
7TPSE1 7TPSE2	cucina a piastre elettriche top da appoggio electric single plates top range	400x700x280 800x700x280	2,6x2 2,6x4		5,2 10,4	400\50 400\50	
7CPSE2FE	cucina a piastre elettriche base con forno elettrico electric single plates range on electric oven	800x700x900	2,6x4	6	15,5	400\50	gn 2/1
7CVCE1A 7CVCE2A	cucina vetroceramica base a giorno electric pyroceram on open base	400x700x900 800x700x900	4,4x1 4,4x2		4,4 8,8	400\50 400\50	
7TVCE1 7TVCE2	cucina vetroceramica top da appoggio electric pyroceram top range	400x700x280 800x700x280	4,4x1 4,4x2		4,4 8,8	400\50 400\50	
9CPSE1A 9CPSE2A	cucina a piastre elettriche base a giorno electric single plates range on open base	400x900x900 800x900x900	2,6x2 2,6x4		5,2 10,4	400\50 400\50	
9TPSE1 9TPSE2	cucina a piastre elettriche top da appoggio electric single plates top range	400x900x280 800x900x280	2,6x2 2,6x4		5,2 10,4	400\50 400\50	
9CPSE2FE	cucina a piastre elettriche base con forno elettrico electric single plates range on electric oven	800x900x900	2,6x4	6	16,4	400\50	gn 2/1
9CVCE1A 9CVCE2A	cucina vetroceramica base a giorno electric pyroceram on open base	400x900x900 800x900x900	6x1 6x2		6 12	400\50 400\50	
9TVCE1 9TVCE2	cucina vetroceramica top da appoggio electric pyroceram top range	400x900x280 800x900x280	6x1 6x2		6 12	400\50 400\50	
CPSE1A CPSE2A	cucina a piastre elettriche vano a giorno electric single plates on open base	450x900x900 900x900x900	4x2 4x4		8 16	400\50 400\50	300x300 cad./each 300x300 cad./each
CPSE2FE	cucina a piastre elettriche con forno elettrico electric single plates with electric oven	900x900x900	4x4	6	22	400\50	300x300 cad./each + forno GN 2/1
TPSE1 TPSE2	cucina a piastre elettriche top da appoggio electric single plates top range	450x900x250 900x900x250	4x2 4x4		8 16	400\50 400\50	300x300 cad./each 300x300 cad./each

**Preparazione / Preparation / Preparation / Vorbereitung**

<b>CODICE</b> CODE CODE ARTIKELNR	<b>DESCRIZIONE</b> DESCRIPTION DESCRIPTION BESCHREIBUNG	<b>DIMENSIONI</b> DIMENSIONS DIMENSIONS MAßE	<b>NUMERO CASSETTI</b> DRAWERS NUMBER NOMBRE DE TIROIRS ANZAHL DER SCHUBLADEN
7CNN1A 7CNN1A 7CNN2A	basi neutre a giorno neutral base on open cupboard	400x700x900 450x700x900 800x700x900	
7TNN1 7TNN11 7TNN2	top neutro da appoggio neutral top range	400x700x900 450x700x900 800x700x900	
7CCN1 7CCN11	basi neutre con cassetti neutral base with drawers	400x700x900 450x700x900	3 3

<b>CODICE</b> CODE CODE ARTIKELNR	<b>DESCRIZIONE</b> DESCRIPTION DESCRIPTION BESCHREIBUNG	<b>DIMENSIONI</b> DIMENSIONS DIMENSIONS MAßE	<b>KW</b> KW KW KW	<b>KW FORNO</b> KW OVEN KW FOUR KW OFEN	<b>KW TOT</b> KW TOT KW TOT KW TOT	<b>V\HZ</b> V\HZ V\HZ V\HZ	<b>CAPACITÀ</b> CAPACITY CAPACITE KAPAZITÄT
CPSE1A CPSE2A	cucina a piastre elettriche vano a giorno electric single plates range on open base	450x900x900 900x900x900	4x2 4x2		8 16	400/50 400/50	300x300 cad./each
CPSE2FE	cucina a piastre elettriche base con forno elettrico electric single plates with electric oven	900x900x900	4x4	6	22	400/50	300x300 cad./each + forno GN 2/1
TPSE1 TPSE2	cucina a piastre elettriche top da appoggio electric single plates top range	450x900x250 900x900x50	4x2 4x4		8 16	400/50 400/50	300x300 cad./each

# Sistemi di cottura ad incasso



## Drop-in cooking system Systèmes de cuisson à encastrer Einbau-Kochsysteme



La gamma comprende le versioni elettriche più usate della cottura.  
Il campo di applicazione è vastissimo, si spazia da una piccola cucina integrata realizzata a misura ad un self service o ad un banco bar.  
- Il foro sul piano è intercambiabile.  
- Il posizionamento dei comandi può essere stabilito volta per volta a seconda delle esigenze del Cliente.  
- Questo sistema ha la massima versatilità e lo stesso rendimento della serie 700 professionale.



Range includes electric version most used in cooking.  
The application it's very extensive, from the small kitchen integrated made to measure to a self-service or a bar counter.  
- Hole on worktop is interchangeable.  
- Placement of controls can be fixed each time up to Customer needs.  
- This system has the maximum versatility and the same efficiency of series 700 professional.



La gamme prévoit les versions électriques de la cuisine la plus utilisée.  
Les possibilités d'utilisation sont très vastes, à partir d'une petite cuisine intégrée et étudiée sur mesure jusqu'à un self-service ou au comptoir d'un bar.  
- Die Öffnung auf der Arbeitsfläche ist austauschbar.  
- Der Bedienungskasten kann je nach Kundenwunsch positioniert werden.  
- Höchste Vielseitigkeit und Leistung der 700 Linie.



Das sortiment umfasst elektrische versionen gebrauchtes speise.  
Das Applikationsfeld ist sehr groß und geht von den kleineren angepassten Küchen bis zum Self-Service oder Barthecken.  
- Position de la découpe sur le plan au choix du Client.  
- Commandes placées selon exigences.  
- Ce système offre beaucoup de possibilités alternatives et donne les même résultats que la série 700 professionnelle.



### Sistemi di cottura ad incasso Drop-in cooking system Systèmes de cuisson à encastrer Einbau-Kochsysteme

CODICE CODE CODE ARTIKELNR	DESCRIZIONE DESCRIPTION DESCRIPTION BESCHREIBUNG	DIMENSIONI DIMENSIONS DIMENSIONS MAßE	KW KW KW KW	KW TOT KW TOT KW TOT KW TOT	V\HZ V\HZ V\HZ V\HZ	CAPACITÀ CAPACITY CAPACITÉ KAPAZITÄT
7DPSE1 7DPSE2	drop-in piastre singole elettriche electric single plate built in	400x700 800x700	5,2x1 5,2x2	5,2 10,4	400\50 400\50	
7DCPE1 7DCPE2	drop-in cuocipasta elettrico electric pasta cooker built in	400x700 800x700	7x1 7x2	7 14	400\50 400\50	28 L 28X2 L
7DVCE1	drop-in vetroceramica elettrico electric pyroceram built in	400x700	4,4	4,4	400\50	

# Pentole

## Boiling pans

## Marmites

## Töpfe



### Pentole indirette elettriche Pentole indirette a gas Pentole dirette a gas

Vasca di cottura con fondo in AISI 316 specifico per trattare prodotti particolarmente acidi e pareti in AISI 304. Intercapedine in AISI 304. Coperchio bilanciato in AISI 304 dotato di maniglia atermica. Cerniera a baionetta per modelli da 50 lt. Isolamento termico garantito da pannelli in fibra di vetro di grosso spessore.



### Indirect electric boiling pans Indirect gas boiling pans Direct gas boiling pans

Cook tank with AISI 316 bottom specifically for particularly acidic products and walls made out of AISI 304. Tub made out of AISI 304. Balanced lid in AISI 304 equipped with heat absorbing handle. Bayonet hinge for 50 lt. models. Thermal insulation ensured by thick fibreglass panels



### Marmites indirectes électriques Marmites indirectes à gaz Marmites directes à gaz

Bac de cuisson avec fond en AISI 316 spécifique le traitement des produits très acides et parois en AISI 304. Chambre vide en AISI 304. Couvercle balancé en AISI 304 équipé d'une poignée non-thermique. Charnière à encastrer pour les modèles de 50 l. Isolation thermique garantie par des panneaux en fibre de verre ayant une épaisseur importante.



### Elektro-Kochkessel indirekt beheizt Gas-Kochkessel indirekt beheizt Gas-Kochkessel direkt beheizt

Kochwanne mit Boden aus AISI 316 zur Behandlung, speziell für säurehaltige Produkte mit Seitenteilen aus AISI 304. Zwischenmantel aus AISI 304. Federentlasteter Deckel aus AISI 304 mit thermisch nichtleitendem Griff. Bajonettcharnier für 50 lt. Modelle. Die thermische Isolierung wird durch starke Glasfasern garantiert.



**Pentole**  
Boiling pans  
Marmites  
Töpfe

CODICE CODE CODE ARTIKELNR	DESCRIZIONE DESCRIPTION DESCRIPTION BESCHREIBUNG	DIMENSIONI DIMENSIONS DIMENSIONS MAßE	KW TOT KW TOT KW TOT KW TOT	V\HZ V\HZ V\HZ V\HZ	CAPACITÀ CAPACITY CAPACITE KAPAZITÄT
PM7DG050	pentola a gas diretta / direct gas boiling pan	800x700x900	15,5		50 L
PM7IG050	pentola a gas indiretta / indirect gas boiling pan	800x700x900	15,5		50 L
PM7IE050	pentola elettrica indiretta / indirect electric boiling pan	800x700x900	9	400\50	50 L
PM8DG100	pentola a gas diretta	800x900x900	21		100 L
PM8DG150	direct gas boiling pan	800x900x900	21		150 L
PM8IG100	pentola a gas indiretta	800x900x900	21		100 L
PM8IG150	indirect gas boiling pan	800x900x900	21		150 L
PM8IE100	pentola elettrica indiretta	800x900x900	16	400\50	100 L
PM8IE150	indirect electric boiling pan	800x900x900	18	400\50	150 L

# Brasiere



Bratt-pans  
Cuiseurs  
Bräter

 **Brasiere rettangolari** - Vasca di cottura con fondo in FE 360 e pareti in AISI 304. Recipiente con ribaltamento manuale su asse anteriore con vite s/fine comandata da volantino. Coperchio bilanciato in AISI 304 dotato di maniglione ergonomico o maniglie in materiale atermico.

- Gas - Riscaldamento tramite bruciatori tubolari ad alto rendimento. Accensione tramite sistema a carica continua alimentato da una pila (1,5 V) e fiamma pilota. Valvola termostatica con sistema di sicurezza a termocoppia e regolazione temperatura da 50°C a 300°C. Immissione acqua tramite rubinetto e canna di erogazione fissata sul camino.
- Elettrico - Riscaldamento tramite resistenze corazzate in lega Incoloy-800. Termostato per regolazione temperatura da 45°C a 300°C. Termostato di sicurezza in caso di funzionamento anomalo. Immissione acqua in vasca tramite rubinetto e canna di erogazione fissata sul camino.

 **Rectangular brazier** - Cook tank with FE 360 bottom and walls made out of AISI 304. Tank with manual tilting on the front axis with handwheel controlled screws. Balanced lid in AISI 304 equipped with ergonomic handle or handles made out of heat absorbing material.

- Gas - Heating through high performance tubular burners. Ignition using a continuous load powered by a (1.5 V) battery and pilot flame. Thermostatic valve with thermocouple safety system and temperature adjustment from 50°C to 300°C. Water intake via tap and spout mounted on the stack.
- Electric - Heating through armored alloy elements in Incoloy-800. Thermostat for adjusting temperature from 45°C to 300°C. Safety thermostat in case of malfunction. Water intake via tap and spout mounted on the stack.

 **Cuiseurs rectangulaires** - Bac de cuisson avec fond en FE 360 et parois en AISI 304. Conteneur avec renversement manuel sur l'axe antérieur par une vis sans fin contrôlée par un petit volant. Couvercle équilibré en AISI 304 équipé d'une grande poignée ergonomique ou de poignées en matériau non-thermique.

- Gaz - Chauffage moyennant des brûleurs tubulaires très performants. Allumage par système de chargement continu alimenté par une pile (1,5 V) et flamme pilote. Soupape thermostatique avec système de sécurité par thermocouple et réglage de la température de 50°C à 300°C. Introduction de l'eau par robinet et col de cygne installés sur la cheminée.
- Electrique - Chauffage moyennant des résistances blindées en alliage Incoloy-800. Thermostat pour le réglage de la température de 45°C à 300°C. Thermostat de sécurité en cas de fonctionnement incorrect. Introduction de l'eau dans le bac par robinet et col de cygne installés sur la cheminée.

 **Rechteckige Bräter** - Kochwanne mit Boden aus FE 360 und Seitenteilen aus AISI 304. Behälter mit manueller Kippung auf Vorderachse mit Endlosschraube, mit Handrad gesteuert. Federentlasteter Deckel aus AISI 304 mit ergonomischem Griff oder thermisch nichtleitendem Griff.

- Gas - Mit Hochleistungs-Brennerstäben beheizt. Einschalten mit System mit kontinuierlicher Ladevorrichtung, versorgt durch eine Batterie (1,5 V) und mit gesteuerter Flamme. Thermostatische Ventile Strahlungsthermoelement mit Sicherheitssystem Und Temperatureinstellung von 50°C bis 300°C. Wassereinlass durch Wasserhahn und am Kamin befestigtes Auslaufrohr.
- Elektro - Beheizung durch gekapselte Incoloy-800 Widerstände. Thermostat zur Regulierung der Temperatur von 45°C bis 300°C. Sicherheitsthermostat für den Fall von Funktionsstörungen. Wassereinlass durch Wasserhahn und am Kamin befestigtes Auslaufrohr.



Brasiere  
Bratt-pans  
Cuiseurs  
Bräter

CODICE CODE CODE ARTIKELNR	DESCRIZIONE DESCRIPTION DESCRIPTION BESCHREIBUNG	DIMENSIONI DIMENSIONS DIMENSIONS MAÛE	KW TOT KW TOT KW TOT KW TOT	V\HZ V\HZ V\HZ V\HZ	CAPACITÀ CAPACITY CAPACITE KAPAZITÄT	TIPO TYPE TYPE TYP
BM7G050	brasiera gas meccanica / gas bratt pan	800x700x900	12		50 L	a1
BM7E050	brasiera elettrica meccanica / electric bratt pan	800x700x900	8,7	400/50	50 L	
BM8G080	brasiera gas meccanica / gas bratt pan	800x900x900	22		80 L	a1
BM8E080	brasiera elettrica meccanica / electric bratt pan	800x900x900	10	400/50	80 L	

# Predisposizione utenze

Predisposition utilities

Préparation pour connexions de l'eau et de l'électricité

Anschlussvorbereitung

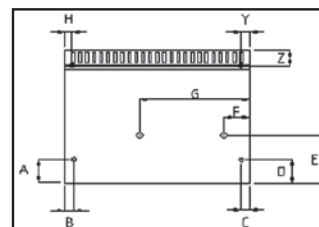

Cucine a gas - Gas coking range - Cuisinières à gaz - Gas Herde

<b>CODICE</b> CODE CODE ARTIKELNR	<b>ALIMENTAZIONE (GAS)</b> POWER (GAS) ALIMENTATION (GAZ) SPEISUNG (GAS) M 1/2" - A X B	<b>SCARICO ACQUA</b> WATER UNLOAD EVACUATION EAU WASSERABLAUF Y X Z	<b>CARICO ACQUA</b> WATER LOAD CHARGEMENT EAU WASSERZULAUF F 1/2" - C X D	<b>SCARICO LIQUIDI</b> LIQUIDS UNLOAD EVACUATION LIQUIDES ABLAUF FLÜSSIGK F 1" - E X F	<b>SCARICO LIQUIDI</b> LIQUIDS UNLOAD EVACUATION LIQUIDES ABLAUF FLÜSSIGK F 1" - E X G
7CCPG1 - 9CCPG1 - 9CCPG1P	210X20	/	30X220	290 X 85	/
7CCPG2 - 9CCPG2 - 9CCPG2P	210X20	/	30X220	290 X 85	290 X 490
7CFFG1SI - 9CFFG1SI - 7/9CFFG1D	215X20	/	/	/	/
7CFFG2SI - 9CFFG2SI - 7/9CFFG2D	215X20	/	/	/	/
7CFFG288 - 9CFFG288	360X40	/	/	/	/
CFFG1 - CFFG2	205X30	/	/	/	/
FRGP45	205X30	/	/	/	/
7CFLG2DA/12	215X40	/	/	/	/
7CFLG2A/12 - 9CFLG2A/12	215X20	/	/	/	/
7CFLG2PA/12 - 9CFLG2PA/12	215X20	/	/	/	/
7CFLG4DA /12	215X40	/	/	/	/
7CFLG4A/12 - 9CFLG4A/12	215X20	/	/	/	/
7CFLG4PA/12 - 9CFLG4PA/12	215X20	/	/	/	/
7CFLG4FG/12 - 9CFLG4FG/12	215X20	/	/	/	/
7CFLG4FGP/12 - 9CFLG4FGP/12	215X20	/	/	/	/
7CFLG4FGD/12	215X20	/	/	/	/
7CFLG6DA/12	215X20	/	/	/	/
7CFLG6A/12 - 9CFLG6A/12	215X20	/	/	/	/
7CFLG6PA/12 - 9CFLG6PA/12	215X20	/	/	/	/
7CFLG6FGD/12	215X20	/	/	/	/
7CFLG6FG/12 - 9CFLG6FG/12	215X20	/	/	/	/
7CFLG6FGP/12 - 9CFLG6FGP/12	215X20	/	/	/	/
7CGG2AV - 9CGG2AV	225 X 20	142X82	30X260	/	/
7CGG2AV - 9CGG4AV	225 X 20	142X82	30X260	/	/
7CGG6AV - 9CGG6AV	225 X 20	142X82	30X260	/	/
CGG2V	205 X 30	142X82	30X260	/	/
CGG4V	205 X 30	142X82	30X260	/	/
CGG6V	205 X 30	142X82	30X260	/	/
7CFTG2LA - 9CFTG2LA	225 X 20	/	/	/	/
7CFTG2LRA - 9CFTG2LRA	225 X 20	/	/	/	/
7CFTG2RA - 9CFTG2RA	225 X 20	/	/	/	/
7CFTG4LA - 9CFTG4LA	225 X 20	/	/	/	/
7CFTG4LRA - 9CFTG4LRA	225 X 20	/	/	/	/
7CFTG4RA - 9CFTG4RA	225 X 20	/	/	/	/
CFTG2LA - CFTG2LRA - CFTG2RA	205 X 30	/	/	/	/
CFTG4LA - CFTG4LRA - CFTG4RA	205 X 30	/	/	/	/
TE1200/FE - TE1200	250 X 45	/	/	/	/
TE1600/FE - TE1600	250 X 45	/	/	/	/
			<b>CARICO ACQUA</b> F 1/2" - A X B		
BM7G050 - BM8G050	280 X 80		360 X 80		
<b>CODICE</b> CODE CODE ARTIKELNR	<b>ALIMENTAZIONE (GAS)</b> POWER (GAS) ALIMENTATION (GAZ) SPEISUNG (GAS) M 1/2" - H X Z	<b>ALIMENTAZIONE (GAS)</b> POWER (GAS) ALIMENTATION (GAZ) SPEISUNG (GAS) M 1/2" - C X D	<b>SCARICO ACQUA</b> WATER UNLOAD EVACUATION EAU WASSERABLAUF Y X Z	<b>CARICO ACQUA</b> WATER LOAD CHARGEMENT EAU F 1/2" - E X F	
7TFLG2D/12	20 X 90	/	/	/	/
7TFLG2/12 - 9TFLG2/12	20 X 90	/	/	/	/
7TFLG2P/12 - 9TFLG2P/12	20 X 90	/	/	/	/
7TFLG4D/12	20 X 90	/	/	/	/
7TFLG4/12 - 9TFLG4/12	20 X 90	/	/	/	/
7TFLG4P/12 - 9TFLG4P/12	20 X 90	/	/	/	/
7TFLG6D/12	20 X 90	/	/	/	/
7TFLG6/12 - 9TFLG6/12	20 X 90	/	/	/	/
7TFLG6P/12 - 9TFLG6P/12	20 X 90	/	/	/	/
7TGG2V - 9TGG2V	19 X 79	/	145X270	30X260	/
7TGG4V - 9TGG4V	19 X 79	/	145X270	30X260	/
7TGG6V - 9TGG6V	19 X 79	/	145X270	30X260	/
TGG2V	30 X 80	/	145X270	30X260	/
TGG4V	30 X 80	/	145X270	30X260	/
TGG6V	30 X 80	/	145X270	30X260	/
7TFTG2L - 9TFTG2L	19 X 79	/	/	/	/
7TFTG2LR - 9TFTG2LR	19 X 79	/	/	/	/
7TFTG2R - 9TFTG2R	19 X 79	/	/	/	/
7TFTG4L - 9TFTG4L	19 X 79	/	/	/	/
7TFTG4LR - 9TFTG4LR	19 X 79	/	/	/	/
7TFTG4R - 9TFTG4R	19 X 79	/	/	/	/
TFTG2L - TFTG2LR - TFTG2R	30 X 80	/	/	/	/
TFTG4L - TFTG4LR - TFTG4R	30 X 80	/	/	/	/
PM7DG050	/	40 X 380	/	580 X 40	/
PM7IG050	/	40 X 380	/	580 X 40	/
PM8DG100	/	40 X 380	/	580 X 40	/
PM8DG150	/	40 X 380	/	580 X 40	/
PM8IG100	/	40 X 380	/	580 X 40	/
PM8IG150	/	40 X 380	/	580 X 40	/



PER TUTTI I FRY-TOP VERSIONE CROMATA (CR) STESSE CARATTERISTICHE

# Predisposizione utenze

Predisposition utilities

Préparation pour connexions de l'eau et de l'électricité

Anschlussvorbereitung

**Cucine a gas passanti** - Open flame loop cookers - Cuisinières à gaz traversantes - Kochherde mit durchgehender Oberfläche und offener Flamme

CODICE CODE CODE ARTIKELNR	ALIMENTAZIONE (GAS) POWER (GAS) ALIMENTATION (GAZ) SPEISUNG (GAS) M 1/2" - A X B	ALIMENTAZIONE (GAS) POWER (GAS) ALIMENTATION (GAZ) SPEISUNG (GAS) M 1/2" - C X D
10PCFLG2A/12	70X215	215X70
10PCFLG2PA/12	70X215	215X70
12PCFLG2A/12	70X215	215X70
12PCFLG2PA/12	70X215	215X70
10PCFLG4A/12	70X215	215X70
10PCFLG4PA/12	70X215	215X70
12PCFLG4A/12	70X215	215X70
12PCFLG4PA/12	70X215	215X70
10PCFLG6A/12	70X215	215X70
10PCFLG6PA/12	70X215	215X70
12PCFLG6A/12	70X215	215X70
12PCFLG6PA/12	70X215	215X70
10PCFLG4FG/12	70X215	215X70
12PCFLG4FG/12	70X215	215X70
10PCFLG4FGP/12	70X215	215X70
12PCFLG4FGP/12	70X215	215X70
10PCFLG6FG/12	70X215	215X70
12PCFLG6FG/12	70X215	215X70
10PCFLG6FGP/12	70X215	215X70
12PCFLG6FGP/12	70X215	215X70

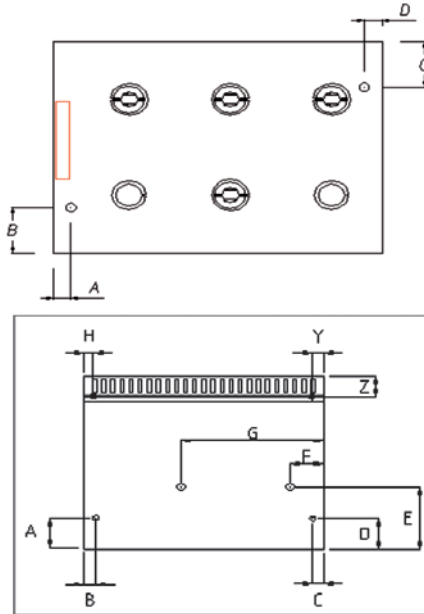

- Schema per risalire alla predisposizione delle utenze a pavimento  
- Scheme for preparation of utilities at the floor  
- Schéma pour préparer les connexions de l'eau et de l'électricité au sol  
- Schemen für die Bodenverlegung der Anschlussvorbereitung



**Cucine elettriche** - Electric range - Cuisinières électriques - Elektro Herde

CODICE CODE CODE ARTIKELNR	ALIMENTAZIONE (ELET) POWER (ELECT) ALIMENTATION (ELECT) SPEISUNG (ELEKT) A X B	ALIMENTAZIONE (ELET) POWER (ELECT) ALIMENTATION (ELECT) SPEISUNG (ELEKT) H X Z	CARICO ACQUA WATER LOAD CHARGEMENT EAU WASSERZULAUF F 1/2" - C X D	SCARICO LIQUIDI LIQUIDS UNLOAD EVACUATION LIQUIDES ABLAUF FLÜSSIGK F 1" - E X F	SCARICO LIQUIDI LIQUIDS UNLOAD EVACUATION LIQUIDES ABLAUF FLÜSSIGK F 1" - E X G
7CCPE1 - 9CCPE1	220 X 27	/	31 X 220	290 x 87	/
7CCPE2 - 9CCPE2	220 X 27	/	31 X 220	290 x 87	290 X 490
7CBME1A - 9CBME1A	220 X 27	/	/	/	/
7CFFE18 - 9CFFE18 - 7/9CFFE18D	220 X 27	/	/	/	/
7CFFE218 - 9CFFE218 - 7/9CFFE218D	220 X 27	/	/	/	/
7CFFE288 - 9CFEE288	220 X 27	/	/	/	/
CFFE1	194 X 30	/	/	/	/
CFFE2	194 X 30	/	/	/	/
7CFTE1LA - 9CFTE1LA	220 X 27	/	/	/	/
7CFTE2LA - 9CFTE2LA	220 X 27	/	/	/	/
7CFTE1LRA - 9CFTE1LRA	220 X 27	/	/	/	/
7CFTE2LRA - 9CFTE2LRA	220 X 27	/	/	/	/
7CFTE1RA - 9CFTE1RA	220 X 27	/	/	/	/
7CFTE2RA - 9CFTE2RA	220 X 27	/	/	/	/
CFTE1LA - CFTE1LA - CFTE1RA	194 X 30	/	/	/	/
CFTE2LA - CFTE2LA - CFTE2RA	194 X 30	/	/	/	/
7CPSE1A - 9CPSE1A	220 X 27	/	/	/	/
7CPSE2A - 9CPSE2A	220 X 27	/	/	/	/
7CPSE2FE - 9CPSE2FE	220 X 27	/	/	/	/
CPSE1A - CPSE2A - CPSE2FE	194 X 30	/	/	/	/
7CVCE1A - 9CVCE1A	220 X 27	/	/	/	/
7CVCE2A - 9CVCE2A	220 X 27	/	/	/	/
7TPSE1 - 9TPSE1	/	60 X 30	/	/	/
7TPSE2 - 9TPSE2	/	60 X 30	/	/	/
7TVCE1 - 9TVCE1	/	60 X 30	/	/	/
7TVCE2 - 9TVCE2	/	60 X 30	/	/	/
7TFTE1 - 9TFTE1	/	60 X 30	/	/	/
7TFTE2 - 9TFTE2	/	60 X 30	/	/	/
7TFTE1LR - 9TFTE1LR	/	60 X 30	/	/	/
7TFTE2LR - 9TFTE2LR	/	60 X 30	/	/	/
7TFTE1R - 9TFTE1R	/	60 X 30	/	/	/
7TFTE2R - 9TFTE2R	/	60 X 30	/	/	/
TFTE1L - TFTE1LR - TFTE1R	/	34 X 38	/	/	/
TFTE2L - TFTE2LR - TFTE2R	/	34 X 38	/	/	/
CODICE CODE CODE ARTIKELNR	ALIMENTAZIONE (ELET) POWER (ELECT) ALIMENTATION (ELECT) SPEISUNG (ELEKT) A X B	ALIMENTAZIONE (ELET) POWER (ELECT) ALIMENTATION (ELECT) SPEISUNG (ELEKT) C X D	CARICO ACQUA WATER LOAD CHARGEMENT EAU WASSERZULAUF F 1/2" - C X D	CARICO ACQUA WATER LOAD CHARGEMENT EAU WASSERZULAUF F 1/2" - A X B	
PM7E050	/	180 X 40	580X40	/	
BM7E050	280 X 40	/	/	360 X 40	
PM8E100	/	180 X 40	580X40	/	
PM8E150	/	180 X 40	580X40	/	
BM8E080	280 X 40	/	/	360 X 40	

PER TUTTI I FRY-TOP VERSIONE CROMATA (CR) STESSA CARATTERISTICA